

Chains and accessories

Part. 705

Loose link for belt

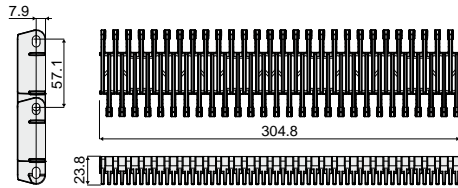
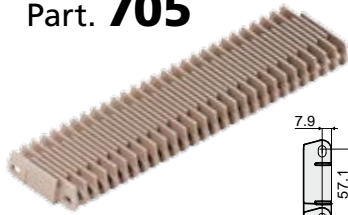

Code
705 / 84208

MATERIALS: Loose links in light brown polypropylene.

FEATURES:

- **Use:** Perfect for use in the food industry, it guarantees a uniform conveyor surface.
- **Max working load:** 29200 N/m (1 mt. belt at + 20°C).
- **Working temperature:** from +5°C to +105°C.
- **Open surface:** 34%
- **Assembly:** with a pin diameter 6 mm (not supplied).

BOX QUANTITY: 24 pieces.

ON REQUEST:

- Loose links: In acetal.
- Belts: Supplied assembled.
- Box quantity: According to your request.

Part. 706

Sprocket / Idler wheel (for Part.705)

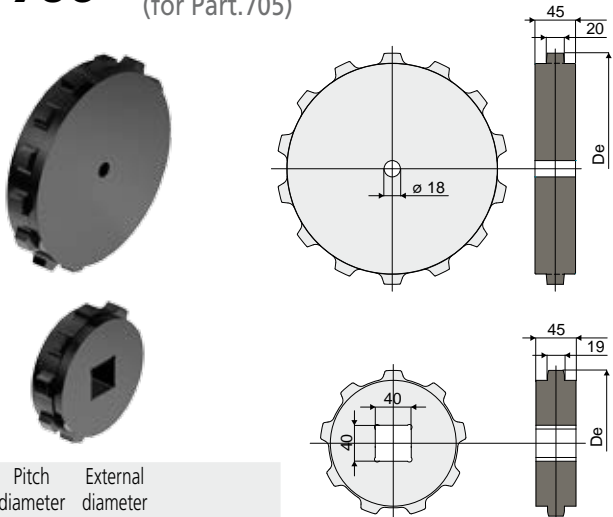

N. teeth	Pitch diameter	External diameter	Code
	Dp (mm)	De (mm)	
14	256,82	256,5	706 / 84209
9	167,08	164,1	706 / 85850

MATERIALS: Sprockets in black polyamide.

FEATURES: To be used with modular belts Part.705.

BOX QUANTITY: 8 pieces.

ON REQUEST:

- Box quantity: According to your request.

Part. 707

Transfer comb (for Part.705)

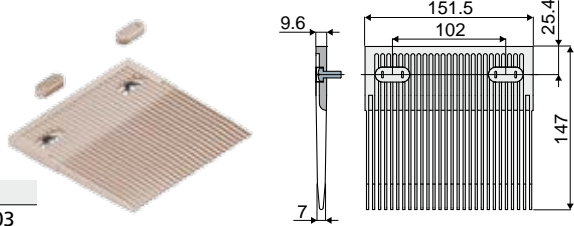

Code
707 / 88703

MATERIALS: Comb and screw caps in light brown polypropylene, M6 screws in stainless steel.

FEATURES: To be used with modular belts Part. 705.

The type of mounting depends on the operating temperatures.

BOX QUANTITY: 24 pieces.

ON REQUEST:

- Box quantity: According to your request.

Max working load (N / m)

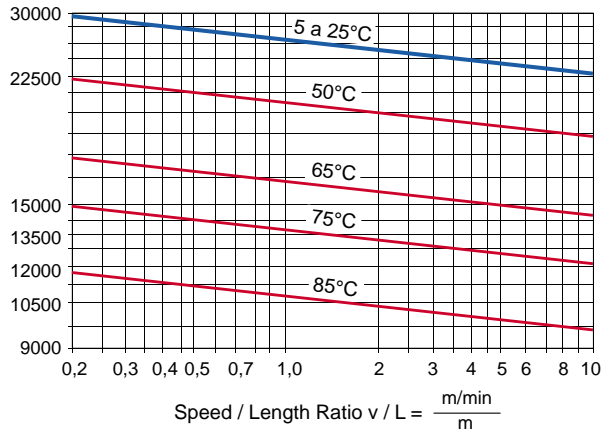

Position of the transfer comb

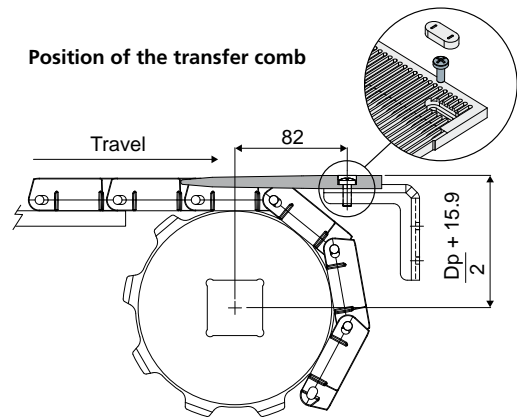

Assembly at room temperature (20° C)

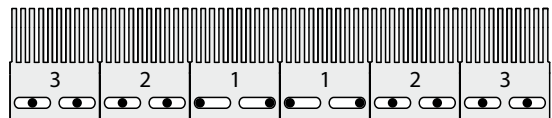

Low temperature assembly

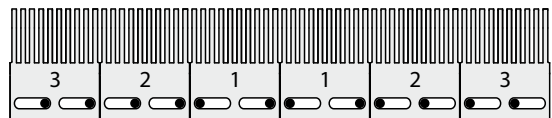

High temperature assembly

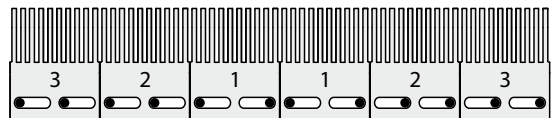

Center of the chain